



Drive Unit HPR50



User Manual
EN

1 Safety



These instruction contains information that you must observe for your personal safety and to prevent personal injury and damage to property. They are highlighted by warning triangles and shown below according to the degree of danger.

- ▶ Read the instructions completely before start-up and use. This will help you to avoid hazards and errors.
- ▶ Keep the manual for future reference. This user manual is an integral part of the product and must be handed over to third parties in case of resale.

NOTE

Also observe the additional documentation for the other components of the HPR50 drive system as well as the documentation enclosed with the e-bike.

1.1 Hazard classification

DANGER

The signal word indicates a danger with a **high** degree of risk which will result in death or serious injury if not avoided.

WARNING

The signal word indicates a danger with a **medium** level of risk which will result in death or serious injury if not avoided.

CAUTION

The signal word indicates a danger with a **low** level of risk which could result in a minor or moderate injury if not avoided.













NOTE

A note in the sense of this instruction is important information about the product or the respective part of the instruction to which special attention is to be drawn.

1.2 IMPORTANT SAFETY INSTRUCTIONS

WARNING

When using this product, basic precautions should always be followed, including the following:

-  Read all the instructions before using the product.
-  Do not put fingers or hands into the product.
-  Never subject the Drive Unit to mechanical shocks to prevent damage to the Drive Unit.
-  To reduce the risk of injury, close supervision is necessary when the Drive Unit is used near children.
-   Never open the Drive Unit case or attempt to disassemble the Drive Unit.
-  Do not use this product if the flexible power cord or output cable is frayed, has broken insulation, or any other signs of damage.
-  Do not make any changes to the Drive Unit that affect the performance or maximum supported speed of your Drive Unit. By doing so you endanger yourself and others and possibly violate laws. The warranty will be voided in addition.
-  The walk assist must only be used to push the e-bike. Make sure that both wheels of the e-bike are in contact with the ground. Otherwise, there is a risk of injury.
-  Make sure that your legs are at a safe distance from the pedals when the walk assist is activated. Otherwise there is a risk of injury from the rotating pedals.
-  Do not attempt to modify or repair the product. Check further detail in Chapter "1.3 Intended Use".
-  This equipment is not intended to be used at ambient temperatures less than -5 °C (23 °F) or above ambient temperatures of 40 °C (104 °F)
-  Only use this product within following temperature limits
Operation: -5 °C to 40 °C / 23 °F to 104 °F
Storage: 0 °C to 40 °C / 32 °F to 104 °F



The Drive Unit can heat up during operation depending on the load and other factors, so that the surface of the Drive Unit and nearby components (Drive Unit cover) become hot. Do not touch the Drive Unit with your hands or legs during or after a ride. Otherwise there is a risk of burns.

NOTE

- The warranty expires automatically when the housing of the Drive Unit is opened.
- The Drive Unit may only be removed and installed by an authorized workshop.

1.2.1 Safety instructions for working on the e-bike

Make sure that the HPR50 drive system is no longer supplied with power before doing any work (e.g. cleaning, chain maintenance, etc.) on the e-bike:



-  Switch off the drive system at the Display and wait until the Display has disappeared.

Otherwise, there is a risk that the Drive Unit may start in an uncontrolled way and cause serious injuries, e.g. crushing, pinching or shearing of the hands.

All work such as repair, assembly, service and maintenance be carried out exclusively by a bicycle dealer authorized by TQ.

1.2.2 Riding safety instructions

Observe the following points to avoid injuries due to a fall when starting with high torque:

-  We recommend that you wear a suitable helmet and protective clothing every time you ride. Please observe the regulations of your country.
-  Consider the potentially high torque of the drive when starting up.
-  Select a suitable gear ratio or pedal assistance for starting off to avoid the risk of a wheelie (front wheel lifts off) or rollover.

CAUTION

Risk of injury

Practice the handling of the e-bike and its functions without assistance from the Drive Unit at first. Then gradually increase the assistance mode.

SAVE THESE INSTRUCTIONS

1.3 Intended Use



The Drive Unit HPR50 is intended exclusively for assisting power to your e-bike and must not be used for any other purposes.

Any other use or use that goes beyond this is considered improper and will result in the loss of the warranty. In case of non-intended use, TQ-Systems GmbH assumes no liability for any damage that may occur and no warranty for proper and functional operation of the product.

Intended use also includes observing these instructions and all information contained therein as well as the information on intended use in the supplementary documents enclosed with the e-bike.

Faultless and safe operation of the product requires proper transport, storage, installation and operation.

2 Technical data

2.1 Drive unit

Weight	approx. 1850 g / 4.1 lbs
Continuous rated power	250 W
Torque (max.)	50 Nm
Interface standard of bottom bracket shaft	ISIS
Length of bottom bracket shaft	135 mm / 5.31"
Operating temperature	-5 °C to +40 °C / 23 °F to 104 °F
Storage temperature	0 °C to +40 °C / -4 °F to 104 °F

Tab. 1: Technical data – Drive Unit HPR50

2.2 Speedsensor

Weight	16 g incl. magnet
Mounting position	Left rear dropout

Tab. 2: Technical data – Speedsensor

3 OPERATION

WARNING

- ▶ Do not attempt to modify or repair the product. Check further detail in Chapter "1.3 Intended Use".
- ▶ Only use this product within following temperature limits
Operation: -5 °C to 40 °C / 23 °F to 104 °F
Storage: 0 °C to 40 °C / 32 °F to 104 °F
- ▶ Further safety warnings regarding Risk of Fire, Electric Shock or Injury to persons can be found in the section: "1.2 Important Safety Instructions".

Switch on drive system:

- ▶ Switch on the Drive Unit by **shortly** pressing the button (pos. 1 in Fig. 1) on the Display.

Switch off drive system:

- ▶ Switch off the Drive Unit by **long** pressing the button (pos. 1 in Fig. 1) on the Display.

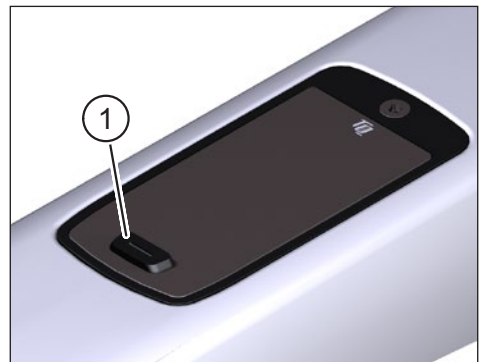

Fig. 1: Display

Please refer to the respective user manual for more information on the initial configuration and the functionalities of the Display.

- ▶ Make sure that the Battery is sufficiently charged before operation.

3.1 General riding notes

3.1.1 Functionality of the drive system HPR50

The HPR50 drive system supports you when riding up to a speed limit permitted by law which may vary depending on your country. The precondition for Drive Unit assistance is that the rider pedals. At speeds above the permitted speed limit, the drive system turns off the assistance until the speed is back within the permitted range.

The assistance provided by the drive system depends firstly on the selected assistance mode and secondly on the force exerted by the rider on the pedals. The higher the force applied to the pedals the greater the Drive Unit assistance.

You can also ride the e-bike without Drive Unit assistance, e.g. when the drive system is switched off or the Battery is empty.

3.1.2 Gear shift

The same specifications and recommendations apply for shifting gears on an e-bike as for shifting gears on a bicycle without Drive Unit assistance.

3.1.3 Riding range

The possible range with one Battery charge is influenced by various factors, for example:

- Weight of e-bike, rider and baggage
- Selected assist mode
- Speed
- Route profile
- Selected gear
- Age and state of charge of the Battery
- Tire pressure
- Wind
- Outside temperature

The range of the e-bike can be extended with the optional Range Extender.

3.2 Mounting position Speedsensor

The speed of the e-bike is measured with support of a magnet (item 2 in Fig. 2) which triggers pulses at the speed sensor (item 1 in Fig. 2). The Speedsensor and magnet are mounted at manufacturer with a distance between 1 mm and 8 mm (see Fig. 2) in the area of the rear wheel.

NOTE

- ▶ Check the correct distance between Speedsensor and magnet if the speed Display shows incorrect values or fails.
- ▶ When performing installation work on the rear wheel, make sure that you do not damage the sensor or the sensor bracket. All work such as repair, assembly, service and maintenance carried out exclusively by a bicycle dealer authorized by TQ.
- ▶ Make sure that the Speedsensor and magnet are free of dirt to avoid signal interference.

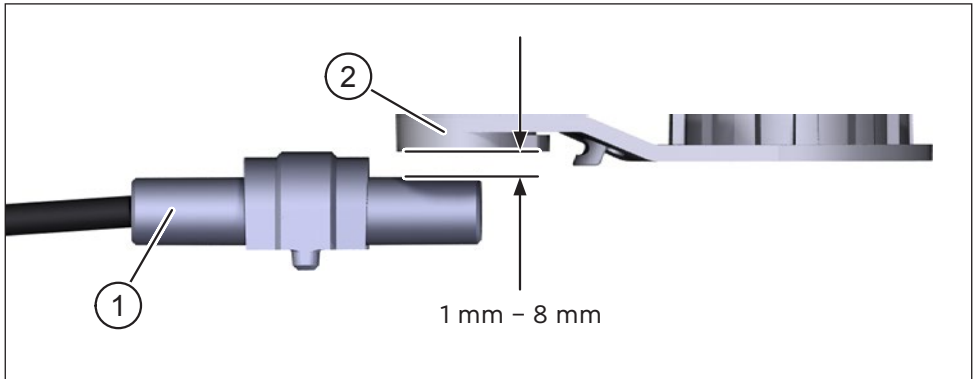

Fig. 2: Mounting – Distance between Speedsensor and magnet

4 TRANSPORT AND STORAGE

- Observe the permissible operating temperature (-5 °C to +40 °C / 23 °F to 104 °F) and storage temperature (0 °C to +40 °C / 32 °F to 104 °F) during transport and storage.
- Observe the country-specific regulations for the transport of e-bikes and batteries.
- Store the motor in a dry place, protected from direct sunlight.

WARNING

Fire or electric shock hazard due to damaged Battery or Range Extender and unintentional start-up of the HPR50 drive system

The rechargeable batteries can be damaged by shocks or impacts during transport. Furthermore, the HPR50 drive system can be started up unintentionally.

- ▶ Take the necessary precautions to prevent the batteries from being damaged or the drive system from starting up.

Please check and read all safety instruction which are included in the Battery and Range Extender manual.

5 USER MAINTENANCE

5.1 Maintenance and Service

All service, repair or maintenance work performed by a TQ authorized bicycle dealer. Your bicycle dealer can also help you with questions about bicycle use, service, repair or maintenance.

5.2 Cleaning

- The components of the HPR50 drive system must only be cleaned with water from a standard household water hose and not with any high-pressure cleaner.
- Before cleaning switch off the drive system on the Display.
- Before Cleaning remove the optional Range Extender if necessary.
- Before cleaning the e-bike check that the cover of the charging port in the bike frame is closed and engaged.
- After cleaning, check that the charging port in the e-bike frame is dry. If there are drops of water on the contacts in the charging port, the e-bike may not be able to be switched on.

6 Environmentally friendly disposal

The components of the drive system and the batteries must not be disposed of in the residual waste garbage can.



- Dispose of metal and plastic components in accordance with country-specific regulations.
- Dispose of electrical components in accordance with country-specific regulations. In EU countries, for example, observe the national implementations of the Waste Electrical and Electronic Equipment Directive 2012/19/EU (WEEE).
- Dispose of batteries and rechargeable batteries in accordance with the country-specific regulations. In EU countries, for example, observe the national implementations of the Waste Battery Directive 2006/66/EC in conjunction with Directives 2008/68/EC and (EU) 2020/1833.
- Observe additionally the regulations and laws of your country for disposal.

In addition you can return components of the drive system that are no longer required to a bicycle dealer authorized by TQ.



NOTE

For more information and TQ product manuals in various language, please visit www.tq-ebike.com/en/support/manuals or scan this QR-Code.



We have checked the contents of this publication for conformity with the product described. However, deviations cannot be ruled out so that we cannot accept any liability for complete conformity and correctness.

The information in this publication is reviewed regularly and any necessary corrections are included in subsequent editions.

All trademarks mentioned in this manual are the property of their respective owners.

Copyright © TQ-Systems GmbH